

包装方法 (带状包装)

● 标准包装数量

系列	形状编号 (尺寸)	产品厚度 (mm)	带状包装种类	间距 (mm)	数量 (个/卷盘)
EZJZ, EZJP	Z(0603)	0.3	冲压载带包装	2	15000
	0(1005)	0.5			10000
	1(1608)	0.8			4000
EZJS	1(1608)	0.8	冲压载带包装	4	4000
	2(2012)	0.8			5000
		1.25			模压载带包装

● 冲压载带包装 (2 mm间距) 0603尺寸

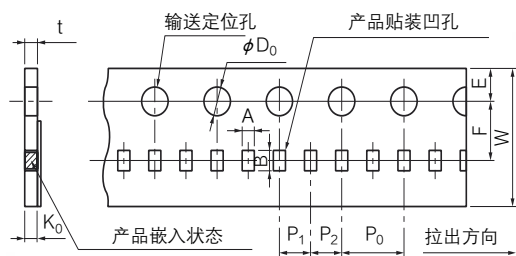

单位: mm

符号	A	B	W	F	E	P ₁	P ₂	P ₀	φD ₀	t	K ₀
EZJZ EZJP	0.36 ±0.03	0.66 ±0.03	8.0 ±0.2	3.50 ±0.05	1.75 ±0.10	2.00 ±0.05	2.00 ±0.05	4.0 ±0.1	1.5 +0.1 0	0.55 max	0.36 ±0.03

● 模压载带包装 (4 mm间距) 2012尺寸

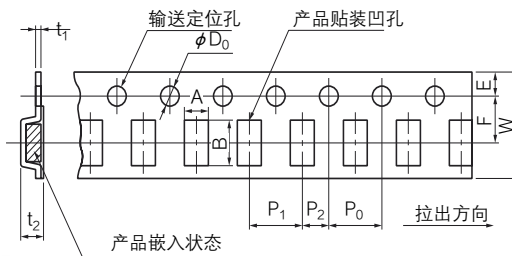

单位: mm

符号	A	B	W	F	E	P ₁	P ₂	P ₀	φD ₀	t ₁	t ₂
EZJS	1.55 ±0.20	2.35 ±0.20	8.0 ±0.2	3.50 ±0.05	1.75 ±0.10	4.0 ±0.1	2.00 ±0.05	4.0 ±0.1	1.5 +0.1 0	0.6 max	1.5 max

● 冲压载带包装 (2 mm间距) 1005尺寸

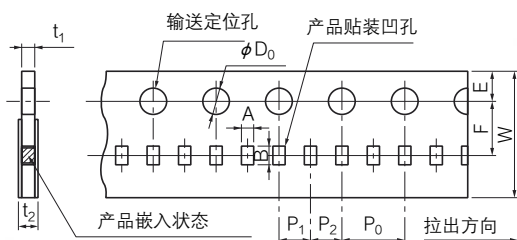

单位: mm

符号	A	B	W	F	E	P ₁	P ₂	P ₀	φD ₀	t ₁	t ₂
EZJZ EZJP EZJS	0.62 ±0.05	1.12 ±0.05	8.0 ±0.2	3.50 ±0.05	1.75 ±0.10	2.00 ±0.05	2.00 ±0.05	4.0 ±0.1	1.5 +0.1 0	0.7 max	1.0 max

● 带状包装用卷盘

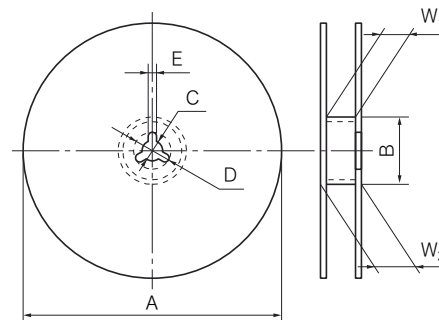

单位: mm

符号	A	B	C	D	E	W ₁	W ₂
EZJZ EZJP EZJS	φ180 ⁰ ₋₃	φ60.0 ^{+1.0} ₀	13.0±0.5	21.0±0.8	2.0±0.5	9.0 ^{+1.0} ₀	11.4±1.0

● 冲压载带包装 (4 mm间距) 1608, 2012, 1410 双连尺寸

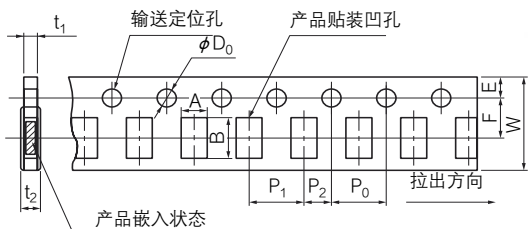

单位: mm

形状符号	A	B	W	F	E	P ₁	P ₂	P ₀	φD ₀	t ₁	t ₂
1 (1608)	1.0 ±0.1	1.8 ±0.1									
S (1410 双连)	1.18 ±0.10	1.63 ±0.10	8.0 ±0.2	3.50 ±0.05	1.75 ±0.10	4.0 ±0.1	2.00 ±0.05	4.0 ±0.1	1.5 +0.1 0	1.1 max	1.4 max
2 (2012)	1.65 ±0.20	2.4 ±0.2									

● 引线部空区规格

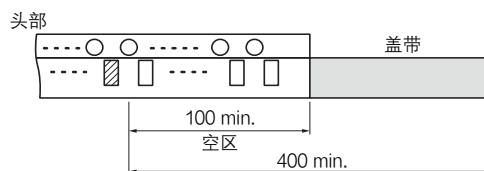

载带尾部

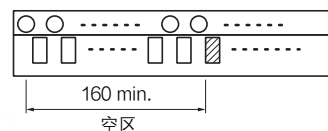

单位: mm