

Metal Composite Type Power Choke Coils

AEC-Q200 Compliant For Use In Harsh Environments

ETQ-PM Series Inductor Product Guide

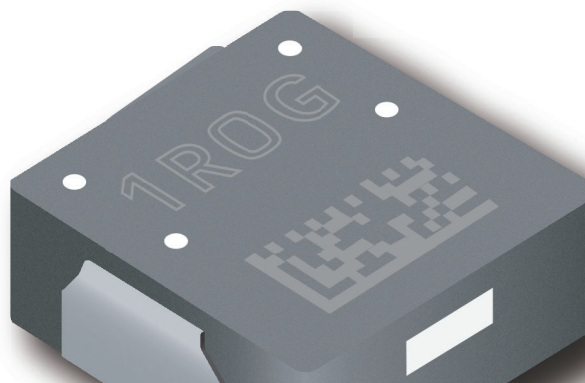
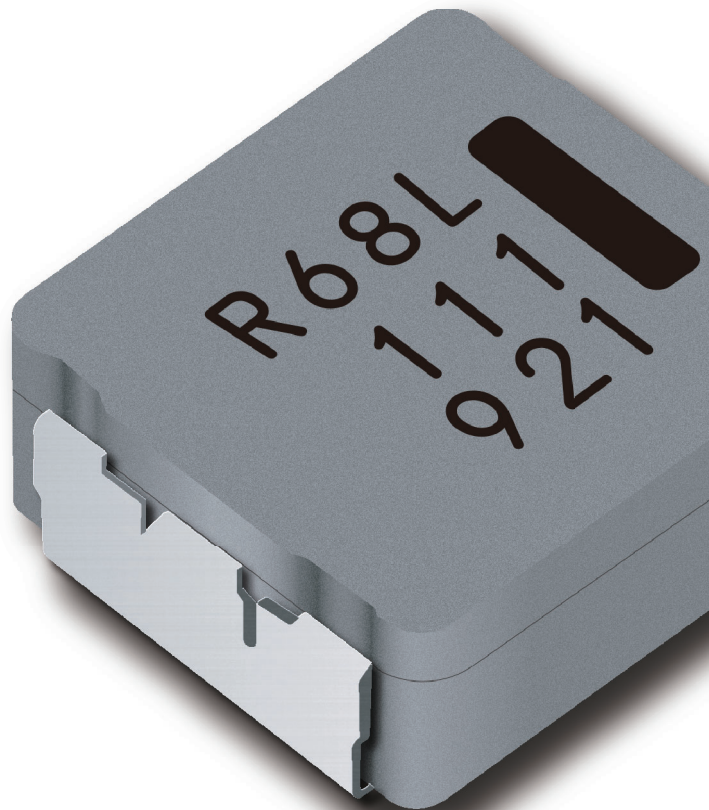
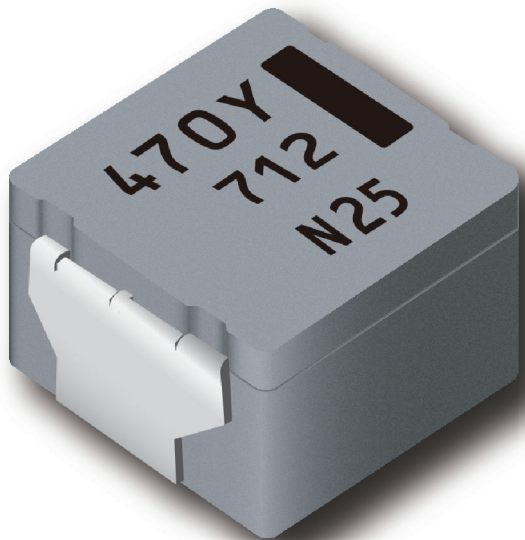







Table of contents

1. Overview	
1-1. Product list & main applications	1
1-2. Introduction	2
2. Features and benefits	
2-1. High current, High heat resistance and excellent thermal stability	3
2-2. Acoustic noise reduction	4
2-3. Low leakage flux	4
2-4. AEC-Q200 compliant for use in harsh environments	5
2-5. Facilitates smaller and lighter designs	5
2-6. Unique terminal structure	6
2-7. Excellent withstanding voltage characteristics	6
3. Panasonic vs Other supplier	
3-1. Panasonic's ETQ-PM series vs alternative products	7
4. For specific requirements	
4-1. Large current, Large size type (12x12mm)	8
4-2. High vibration resistance series	9
4-3. Low profile series	10
5. Explanation of part numbers	
5-1. Panasonic's ETQP series part number breakdown	11
6. Line-up	
6-1. Standard type	12
6-2. LP type / LE type	13
6-3. High power type / Vibration proof type	14
7. Design support tool	
7-1. Simulation data libraries	15
7-2. Industrial & Automotive use LC filter simulator	15
7-3. Power inductor loss simulator	15

1-1. Product list & main applications

Series	Standard	LP / LE	Anti-vibration	4x4 mm	12x12 mm	15x15 mm
Appearance						
Status	MP	MP	MP (Partially)	2021/Q4 to	MP	2022/Q2 to
Size (mm)	5x5 to 10x10	5x5 to 10x10	8x8 to 10x10	4x4	12x12	15x15
L (μH)	0.33 to 100	0.19 to 100	0.68 to 47	0.1 to 4.7	0.33 to 4.7	0.33 to 4.7
I (A)	1.4 to 33.2	1.6 to 32.5	2.9 to 26.3	2.3 to 10.0	16.8 to 44.4	27 to 73
DCR (mΩ)	3.8 to 348	0.9 to 206	1.75 to 125	5.8 to 106.7	0.7 to 4.9	0.4 to 3.0
Vibration (G)	10 to 30	4.4 to 30	30 to 50	10	30	30
Power- train	Engine	✓✓				
	Transmission	✓✓	✓	✓✓		
	Pump	✓✓	✓	✓✓	✓✓	✓✓
	Cooling fan	✓			✓✓	✓✓
EV, HEV, PHV	BMS		✓✓	✓		
	Inverter	✓	✓✓			
	OBC		✓✓			
	48 V DC-DC	✓			✓✓	✓✓
Body, Chassis & Safety	Brake, ABS	✓		✓✓	✓	✓
	Steering, EPS	✓			✓✓	✓✓
	BCM	✓	✓✓		✓	
	Power window	✓	✓✓		✓	
	Lighting	✓	✓✓			
AD / ADAS	DCU	✓	✓		✓✓	✓
	Camera	✓	✓		✓✓	✓
	Rader	✓	✓		✓✓	
	Lidar	✓	✓		✓✓	
	T-Box	✓	✓		✓✓	

✓✓ : Especially recommended
 ✓ : Recommended



Please visit our website
for details !

1-2. Introduction

Panasonic's ETQ-PM Series Metal Composite Type Power Choke Coils are suited for filter, step-down and stepup circuits for DC-DC converters. They are AEC-Q200 Compliant offering reliability when exposed to high temperatures along with a high tolerance to vibration.

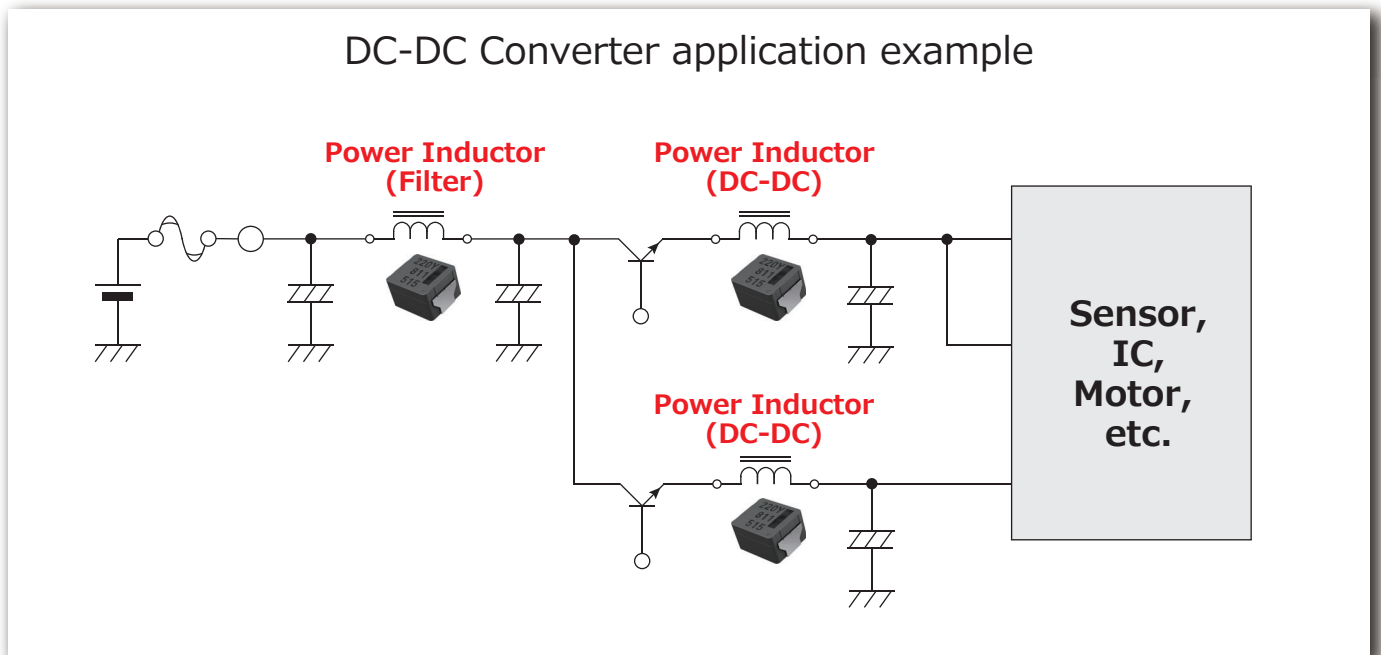

2-1. High current, High heat resistance and excellent thermal stability

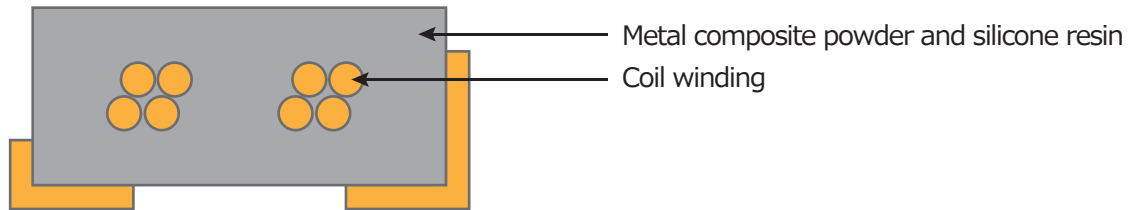

- The ETQ-PM Power Inductor consists of metal powder, silicone resin and coil winding. The magnetic material, which is created from Fe-based powder, enables high current, high heat resistance and excellent thermal stability.
- Excellent magnetic saturation characteristics (i.e. Ferrite core = 0.4T vs. Metal composite type=above 1.5T) make it difficult to magnetically saturate, resulting in good inductance vs. current performance without substantial drop off.
- By using a high temperature capable resin material, an operating temperature up to 150 °C is achievable.

Frequency characteristics of AC resistance

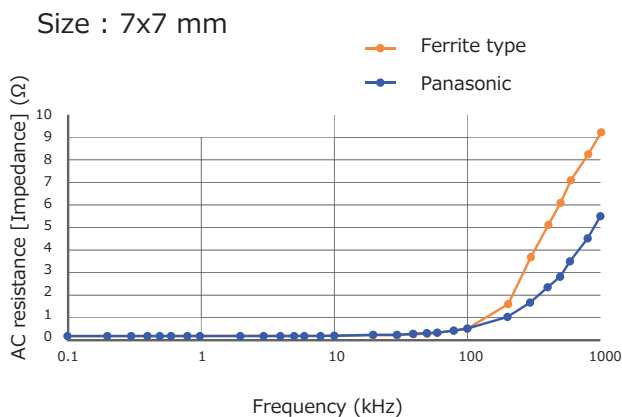

The metal composite molded structure has a distributed gap rather than a discrete gap resulting in low AC resistance (impedance) at higher frequencies.

Effect of DC bias current on inductance

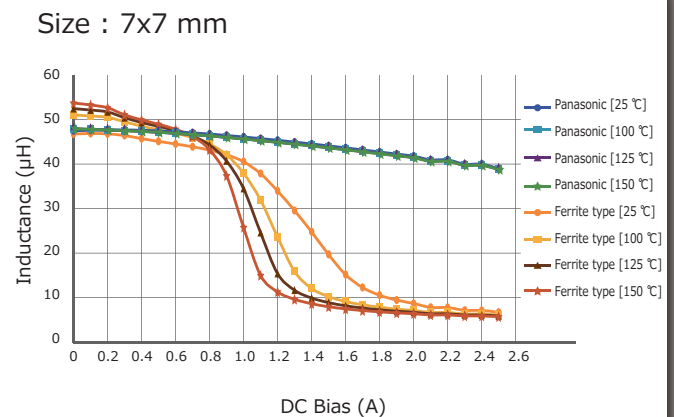

The ETQ-PM Inductor allows for large currents. The inductance levels do not drop significantly as the current increases regardless of the temperature.

Comparison of Panasonic vs. Ferrite type (At the same inductance (current) capability)

Temperature condition 125 °C

Manufacturer	Panasonic metal composite	Ferrite (Alternative product)
Series	M0645	Ferrite type
Size (mm)	6.5 x 6.0	7.4 x 6.9
Height (mm max.)	4.5	4.7
Volume (mm ³)	187	240
Core material	Metal Composite	Ferrite
L1 (μH) at 100 kHz	47.0 (0.8 A)	47.0 (0.7 A)
ISAT (A) at 125 °C, L-10 %	1.3	0.7
DCR (mΩ)	210	158
Performance index per volume	100 %	60 %
Max operating temperature	150 °C	125 °C

Achieved 22% downsizing

2-2. Acoustic noise reduction

Troublesome acoustic noise at audible frequencies is reduced by having a distributed gap structure where the resin replaces the air gap. This enables a large reduction of acoustic noise compared to ferrite types.

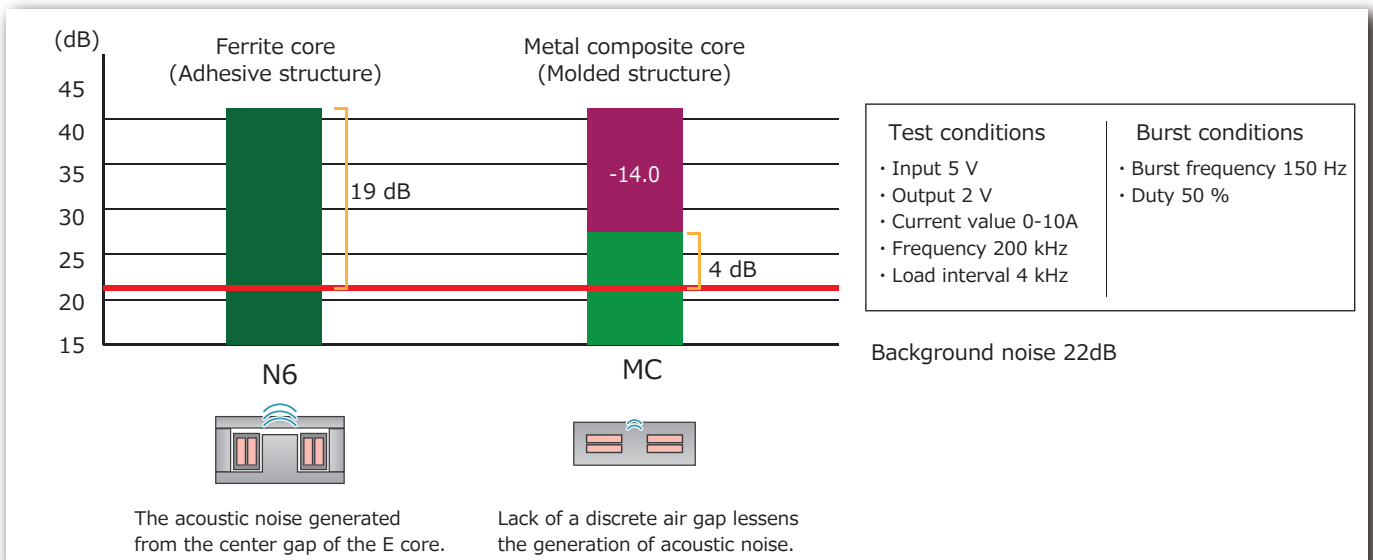

2-3. Low leakage flux

The integrated molded structure of the metal composite type with its distributed gap has low leakage flux from the core resulting in noise and interference reduction, facilitating high density layouts.

2-4. AEC-Q200 compliant for use in harsh environments

Through the previously mentioned improvements, the ETQ-PM Series product provides 150 °C temperature and excellent vibration resistance characteristics.

Reliability results for AEC-Q200 compliant

Item	Condition	Time	Remark
Thermal shock	-40 to +150 °C (Each for 10 minutes)	2000 cycles	<ul style="list-style-type: none"> Inductance is $\pm 10\%$ from initial value DCR is $\pm 10\%$ from initial value Insulation resistance is above 10KΩ Nothing abnormal on appearance and structures No open wire or mechanical damage
Vibration resistance	10 G to 30 G (5 Hz - 2 kHz)	XYZ (Each for 2 hours)	
Heat resistance	150 °C	2000 hours	
High temperature lifetime	150 °C (Rated current applied)		
Anti-Humidity	85 °C, 85%RH	2000 hours	
Anti-Humidity lifetime test	85 °C, 85%RH (Rated current applied)		
Low temperature test	-40 °C	2000 hours	

2-5. Facilitates smaller and lighter designs

Panasonic metal composite core types facilitate smaller designs compared with ferrite type choke coils.

Around 20 - 40 % down in size and 5 - 25 % down in weight.

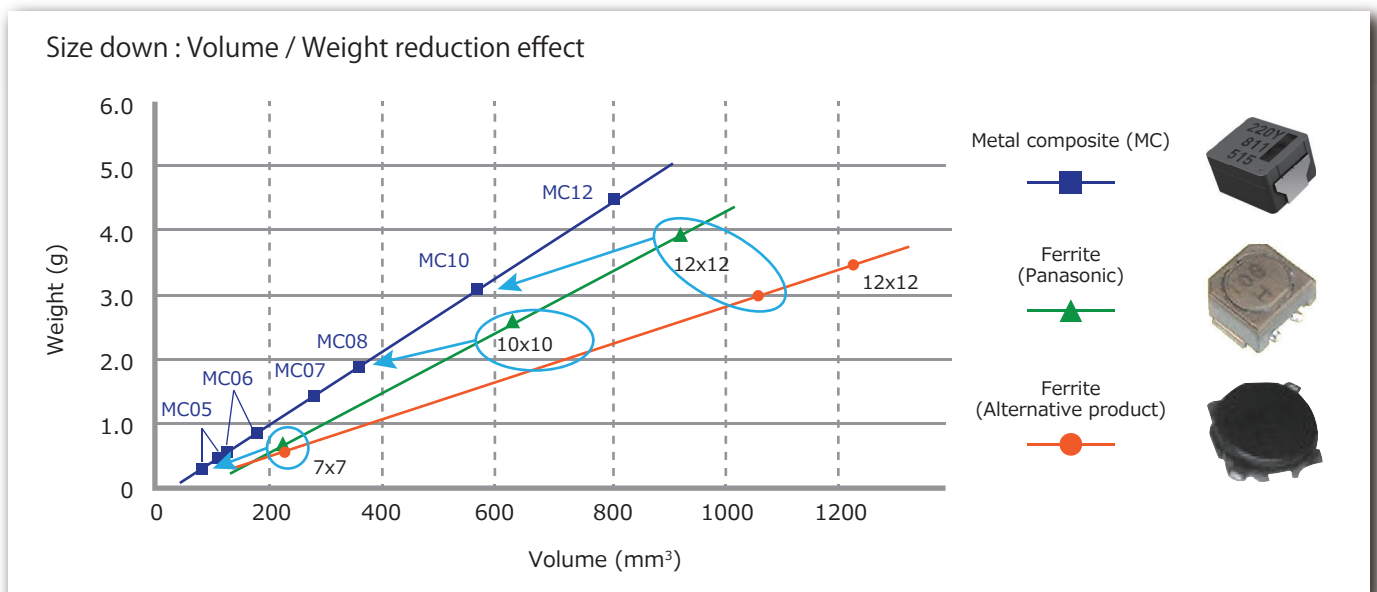

2-6. Unique terminal structure

[Standard type]

The copper wire of the internal coil is brought out directly to the terminal mounting part to ensure the reliability of mounting to the PCB. Other products make the connection inside the Metal Composite, thus it is hard to verify the connection condition and long-term reliability issues may occur with environmental stresses.

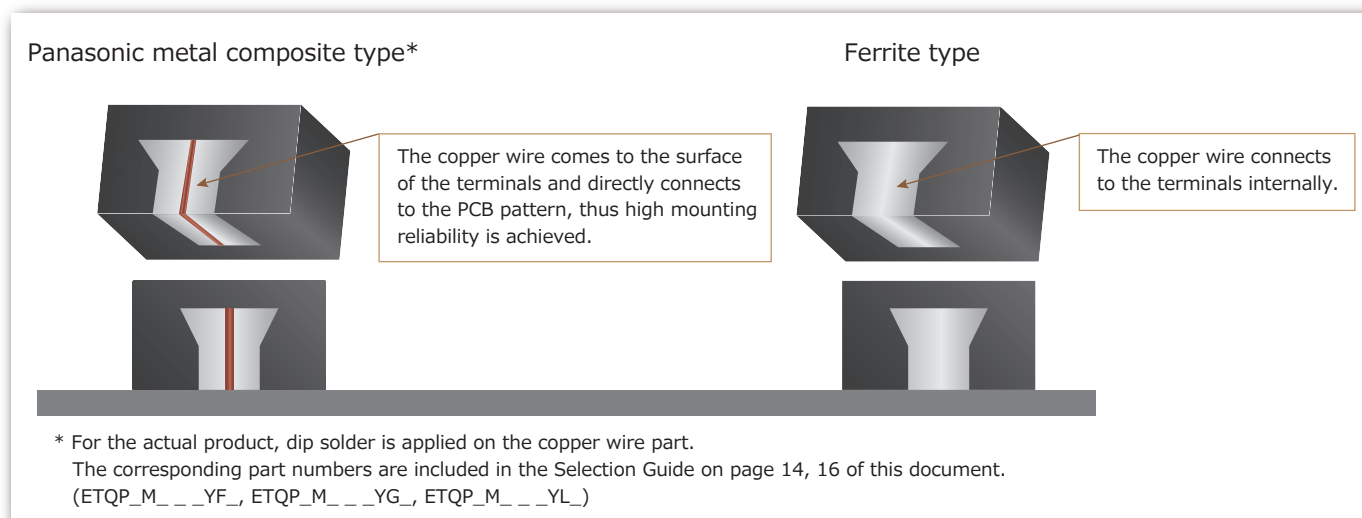

2-7. Developing idea for high voltage proof

Insulation voltage target of Panasonic power choke coils

• High performance series (ETQP_M_ _ _Y_ _)

	Size (mm)	Existing withstand voltage (V)	Revise specification														
			Inductance (μH)														
			0.68	1.0	1.5	2.2/2.5	3.3	4.7	6.8	10	15	22	33	47	68	100	
M0530 M0540	5x5	20		55 V													
M0630 M0645	6x6	25	60 V										55 V				
M0750 M0754	7x7	35			65 V							60 V					
M0850 M0854	8x8	35			70 V					65 V							
M1050 M1054	10x10	35			70 V										65 V		
M1050L M1054L	10x10	35	70 V														

• Low profile series (ETQP_M_ _ _KV_ _)

	Size (mm)	Existing withstand voltage (V)	Revise specification													
			Inductance (μH)													
			0.68	1.0	1.5	2.2/2.5	3.3	4.7	6.8	10	15	22	33	47	68	100
M0530LP	5x5	25	55 V							50 V						
M0630LP	6x6	25	60 V							55 V						
M0840LP	8x8	35	65 V													
M1040LP	10x10	35		65 V										60 V		

3

Panasonic vs Other supplier

3-1. Panasonic' s ETQ-PM series vs. alternative products

With unique metal magnetic material technology, the ETQ-PM Series displays low loss and downsizing compared with alternative products.

Panasonic vs. alternative products

Manufacturer	Panasonic		Alternative products	Panasonic		Alternative products
	8x8.5x5.4 ETQ-P5M220YFK	10x10.7x5.4 ETQ-P5M220YFC	10x10.7x4.0 22 μ H	8x8.5x5.4 ETQ-P5M470YFK	10x10.7x5.4 ETQ-P5M470YFC	10x10.7x4.0 47 μ H
Size (mm) Power inductor	8x8.5x5.4 ETQ-P5M220YFK	10x10.7x5.4 ETQ-P5M220YFC	10x10.7x4.0 22 μ H	8x8.5x5.4 ETQ-P5M470YFK	10x10.7x5.4 ETQ-P5M470YFC	10x10.7x4.0 47 μ H
Frequency (kHz)	400	400	400	400	400	400
DCR 20 °C (m Ω)	63	45	70	125	96	165
ACR (m Ω)	1190	861	1254	2416	2171	2805
Rated current (A)	4.33	4.33	4.33	2.47	2.47	2.47
Iac [Ripple] (A)	1.11	1.11	1.11	0.52	0.52	0.52
Idc RMS (A)	4.42	4.42	4.42	2.51	2.51	2.51
Iac RMS (A)	0.64	0.64	0.64	0.30	0.30	0.30
DC loss (W)	1.65	1.18	1.83	1.06	0.81	1.39
AC loss (W)	0.46	0.34	0.52	0.22	0.20	0.25
Total loss	2.11	1.51	2.35	1.27	1.01	1.65
Δ T [Top] (K)	78.1	49.9	80.9	47.1	33.2	56.8
Δ T [Terminal] (K)	58.0	35.5	58.6	35.0	23.6	41.1

4-1. Large current, large size type (12x12mm)

Features

Target applications

- Filters/DC-DC converters for below applications, etc.

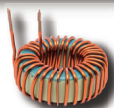
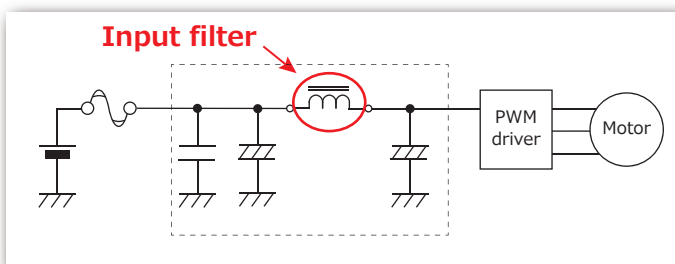
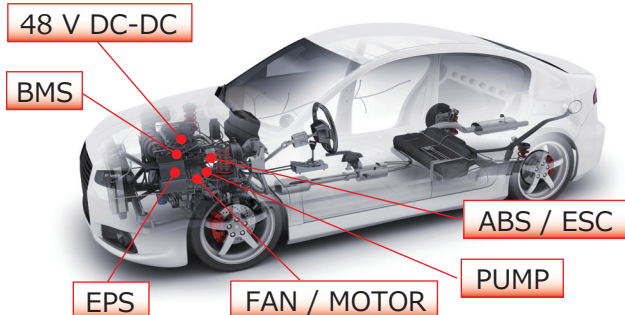

THD → SMD



Reliability

- High vibration resistance by 4-point fixing 30 G / 5 Hz to 2000 Hz



- "Internal coil=Lead wire=terminal" achieves very high reliability electrode structure
- High heat resistance $\geq 160\text{ }^\circ\text{C}$

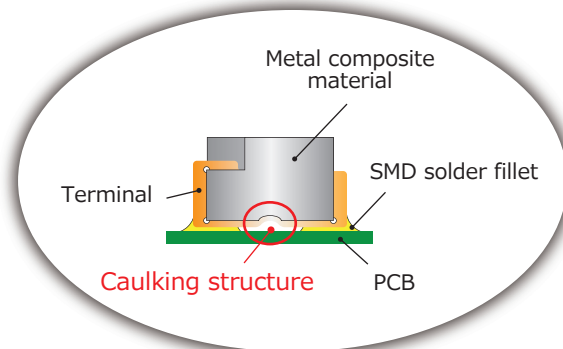

Line up and benchmark

Other company		
Alternative products		
Size : 17.2 x 17.2 x 7.0 (mm)		
L0 (μH)	DCR (m Ω)	Rated current (A) $\Delta\text{T: } +40\text{ K}$
4.7	4.90	24
3.3	3.10	32.2
2.2	2.25	38.5
1.5	-	-
1.0	1.36	53.0
0.68	-	-
0.47	0.89	65.0
0.33	-	-



Panasonic			
PCC-M1280MF			
Size : 12.6 x 13.2 x 8.0 (mm)			
L0 (μH)	DCR (m Ω)	Rated current (A) $\Delta\text{T: } +40\text{ K}$	Saturation current (A) $\Delta\text{T: } -30\text{ \%}$
4.7	4.90	20.2	224.7
3.3	3.10	23.6	27.6
2.2	2.60	27.7	32.1
1.5	1.80	33.3	29.9
1.0	1.36	38.3	44.4
0.68	1.10	42.6	56.9
-	-	-	-
0.33	.070	53.5	84.5

45% Less space

SOP 2022

In MP

4-2. High vibration resistance series

Features

Target applications

- Engine direct attachment, mechanical and electrical integration system applications

Reliability

- Vibration 30 to 50 G/10⁸ times/150 °C
Frequency ≤ 2000Hz, SRF ≥ 3000Hz

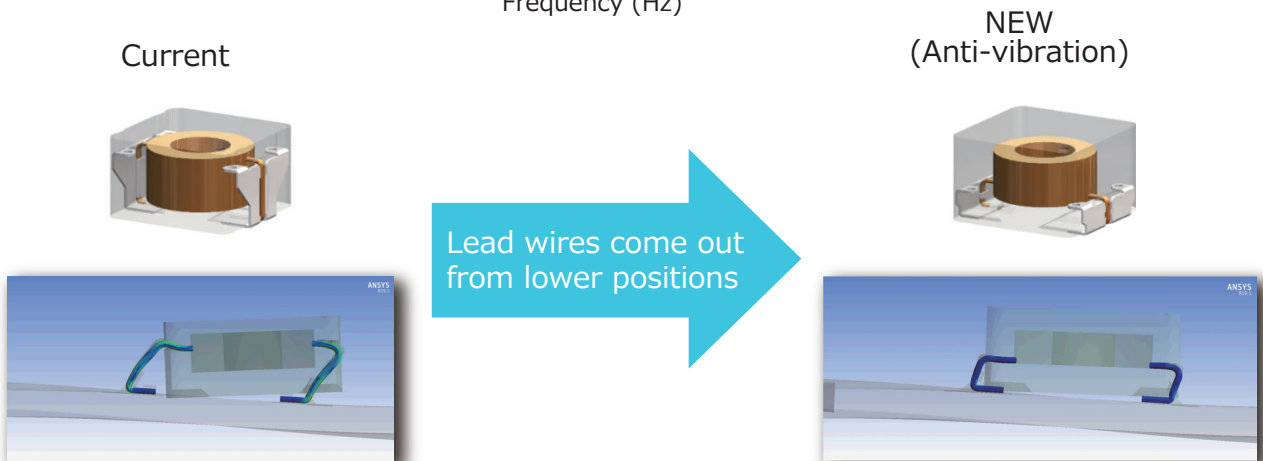
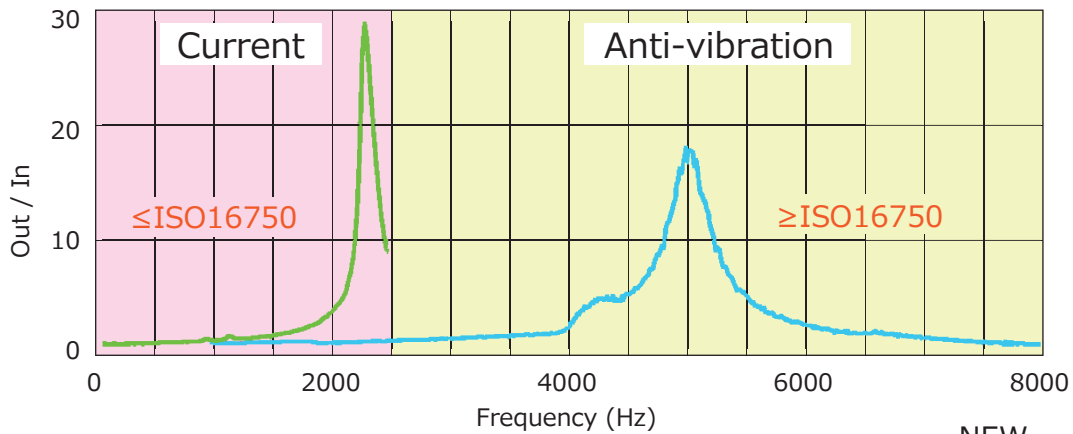

10.9 x 10.0 x H5-6 (mm)			8.5 x 8.0 x H5-6 (mm)		
L0 (μH)	DCR (mΩ)	Rated current (A) ΔT: +40 K	L0 (μH)	DCR (mΩ)	Rated current (A) ΔT: +40 K
47	99.0	3.50	47	125	2.90
33	68.5	4.20	33	100	3.30
22	45.0	5.20	22	63.0	4.10
10	23.8	7.10	10	33.4	5.70
4.7	8.70	11.8	4.7	16.8	8.00
3.3	6.00	14.2	3.3	9.60	10.6
2.5	4.55	16.3	2.5	7.60	11.9
2.0	4.60	16.2	-	-	-
1.5	3.10	19.8	-	-	-
1.0	2.30	23.0	-	-	-
0.68	1.75	26.3	-	-	-



Proto-line sample available

In MP

* Sample LT: 1 to 2 months

4-3. Low profile series

5 x 5 size 5.5 x 5.0 x 3.0 (mm)				
L (μH)	Panasonic ETQP3M__KVP		Alternative products	
	DCR (m Ω)	Isat -20% (A)	DCR (m Ω)	Isat -20% (A)
47	-	-	-	-
33	-	-	-	-
22	-	-	-	-
10	96.0	3.4	132	1.6
6.8	65.7	4.5	104	2.2
4.7	45.6	5.4	72.8	3.7
3.3	27.3	5.8	44.0	5.5
2.2	20	7.4	24.7	6.3
1.5	12	9.6	18.0	7.1
1.0	9.6	11.4	11.5	8.0
0.68	7.6	11.3	9.1	8.2

6 x 6 size 6.4 x 6.0 x 3.0 (mm)				
L (μH)	Panasonic ETQP3M__KVN		Alternative products	
	DCR (m Ω)	Isat -20% (A)	DCR (m Ω)	Isat -20% (A)
47	-	-	-	-
33	-	-	-	-
22	128	2.8	163.0	2.2
10	99.2	3.5	118.0	2.8
6.8	71.0	4.2	71.9	2.9
4.7	45.6	5.5	53.8	4.4
3.3	29	7.2	35.9	5.6
2.2	24.1	7.3	26.5	8.3
1.5	14.5	8.9	17.1	10.8
1.0	6.2	10.7	7.9	13.0
0.68	5.2	11.8	5.38	17.0

8 x 8 size 8.5 x 8.0 x 4.0 (mm)				
L (μH)	Panasonic ETQP4M__KVK		Alternative products	
	DCR (m Ω)	Isat -20% (A)	DCR (m Ω)	Isat -20% (A)
47	-	-	-	-
33	118	3.7	149	3.2
22	76.3	5.0	103	3.8
15	55	5.8	62.0	3.6
10	41.6	6.8	50.0	5.2
6.8	23.5	7.6	-	-
4.7	16.1	9.2	26.6	9.1
3.3	14	11.7	15.4	11.8
2.2	8.5	15.2	11.7	14.0
1.0	3.7	19.1	4.58	16.2
0.68	2.9	21.0	3.3	16.2

10 x 10 size 10.7 x 10.0 x 4.0 (mm)				
L (μH)	Panasonic ETQP4M__KVC		Alternative products	
	DCR (m Ω)	Isat -20% (A)	DCR (m Ω)	Isat -20% (A)
47	132	3.4	167	4.5
33	84.6	4.1	110	4.2
22	60.0	5.6	70.5	6.4
15	37.0	6.0	47.0	7.7
10	25.4	8.1	30.9	8.5
6.8	23.5	8.9	20.9	9.0
4.7	11.8	10.6	14.3	9.2
3.3	12.7	9.4	11.0	12.0
2.2	6.8	16.9	8.15	12.0
1.0	2.6	24.0	2.87	24.0
0.68	-	-	-	-

IDC1 : Direct current based on the L 20% drop from the initial value.

(without drop in L before/after this value because of using Metal composite core)

Operating temperature : up to 150 deg.C (including self-temperature rise)

5

Explanation of part numbers

5-1. Panasonic's ETQP series part number breakdown



Product code

Classification

Height

Winding

Inductance

Core

Suffix

Size

Code	Height (mm max.)
3	3.0 to 3.9
4	4.0 to 4.9
5	5.0 to 5.9
6	6.0 to 6.9
8	8.0 to 8.9

Code	Inductance (μH)
4R7	4.7
220	22
101	100





*Example



Code	Core type
Y	High performance
J	High current
K	Low profile
H	5 MHz

Code	Size (mm)
P	5 x 5
N	6 x 6
M	7 x 7
K	8 x 8
C	10 x 10
A	12 x 12

6-3. High power type / Vibration proof type

Standard type (High-I saturation)

5 x 5				6 x 6											
M0530M		M0540M		M0630M		M0645M									
ETQP3M__YFP		ETQP4M__YFP		ETQP3M__YFN		ETQP4M__YFN									
 5.5 x 5.0 x H3.0 (mm)				 5.5 x 5.0 x H4.0 (mm)				 6.5 x 6.0 x H3.0 (mm)				 6.5 x 6.0 x H4.5 (mm)			
L0 (μ H)	DCR (m Ω)	Rated current (A)		L0 (μ H)	DCR (m Ω)	Rated current (A)		L0 (μ H)	DCR (m Ω)	Rated current (A)		L0 (μ H)	DCR (m Ω)	Rated current (A)	
		Δ L:-30%	Δ T:+40K			Δ L:-30%	Δ T:+40K			Δ L:-30%	Δ T:+40K			Δ L:-30%	Δ T:+40K
												47.0	210.0	3.8	2.2
												33.0	172.0	4.1	2.5
				22.0	163.0	3.1	2.3					22.0	126.0	6.0	2.9
												10.0	54.2	8.3	4.5
												6.8	39.3	10.0	5.2
				4.7	36.0	7.7	4.8								
3.3	31.3	8.6	5.0									3.3	16.1	13.1	8.2
2.2	22.6	10.9	5.8									2.2	10.4	14.4	10.2
								1.0	7.9	20.0	8.8				
								0.68	6.3	24.0	9.8				

7 x 7				8 x 8				10 x 10			
M0754M		M0854M		M1054M							
ETQP5M__YFM		ETQP5M__YFK		ETQP5M__YFC							
 7.5 x 7.0 x H5.4 (mm)				 8.5x 8.0 x H5.4 (mm)				 10.7 x 10.0 x H5.4 (mm)			
L0 (μ H)	DCR (m Ω)	Rated current (A)		L0 (μ H)	DCR (m Ω)	Rated current (A)		L0 (μ H)	DCR (m Ω)	Rated current (A)	
		Δ L:-30%	Δ T:+40K			Δ L:-30%	Δ T:+40K			Δ L:-30%	Δ T:+40K
100.0	348.0	3.1	1.9	100.0	302.0	3.0	2.1	97.0	208.0	3.0	2.7
68.0	251.0	3.9	2.3					68.0	136.0	5.2	3.6
47.0	156.0	4.1	2.9	48.0	125.0	5.4	3.4	47.0	99.0	6.8	4.2
33.0	120.0	4.8	3.3					33.0	68.5	7.6	5.0
22.0	92.0	5.8	3.7	22.0	63.0	6.9	4.8	22.0	45.0	8.8	6.2
				15.0	48.2	7.7	5.5	15.0	35.6	11.2	7.0
10.0	37.6	10.6	5.7	10.0	33.4	13.0	6.7	10.0	23.8	12.0	8.5
6.8	26.7	12.0	6.9								
4.7	20.4	13.1	8.0					4.7	10.2	20.0	13.1
3.3	11.9	14.4	10.4	3.3	9.5	17.9	12.5	3.3	7.1	23.4	14.7
				2.5	7.6	20.1	14.0	3.3	7.1	22.7	15.7
								2.5	5.3	27.2	18.1
								1.5	3.8	35.1	21.4

Please visit our website
for standard type !







← H=5 to YG_

← H=5 to YGC



- ◆ Rated current is the current value at which temperature rise is 40K. Please use within Tc 150°C including self-temperature rise.
- ◆ The proven current value for making the overall temperature rise of 40k, when mounted on multi-layer board with high-heat dissipation.

6-2. LP type / LE type

LP type

5 x 5				6 x 6				8 x 8				10 x 10			
M0530M-LP				M0630M-LP				M0840M-LP				M1040M-LP			
ETQP3M__KVP				ETQP3M__KVN				ETQP4M__KVK				ETQP4M__KVC			
 5.5 x 5.0 x H3.0 (mm)				 6.4 x 6.0 x H3.0 (mm)				 8.5 x 8.0 x H4.0 (mm)				 10.7 x 10.0 x H4.0 (mm)			
L0 (μ H)	DCR (m Ω)	Rated current (A)		L0 (μ H)	DCR (m Ω)	Rated current (A)		L0 (μ H)	DCR (m Ω)	Rated current (A)		L0 (μ H)	DCR (m Ω)	Rated current (A)	
		Δ L:-30%	Δ T:+40K			Δ L:-30%	Δ T:+40K			Δ L:-30%	Δ T:+40K			Δ L:-30%	Δ T:+40K
												47.0	132.0	4.7	3.4
				33.0	206.0	3.0	2.1	33.0	118.0	4.7	3.1	33.0	84.6	5.6	4.2
				22.0	128.0	4.3	2.7	22.0	78.4	6.0	3.8	22.0	60.0	7.4	5.0
				15.0	99.2	5.1	3.0	15.0	55.0	7.6	4.5	15.0	37.0	9.2	6.3
10.0	96.0	4.2	2.4	10.0	71.0	5.8	3.6	10.0	41.6	9.1	5.2	10.0	25.4	10.8	7.6
6.8	65.7	6.1	2.9	6.8	45.6	8.1	4.5	6.8	23.5	11.0	6.9	6.8	18.5	12.1	8.9
4.7	45.6	6.7	3.4	4.7	29.0	9.8	5.6	4.7	16.1	15.1	8.3	4.7	12.3	13.9	11.2
3.3	27.3	8.0	4.4	3.3	24.1	11.5	6.1	3.3	14.1	17.4	8.9	3.3	9.4	17.1	12.6
2.2	20.0	10.1	5.2	2.2	14.5	12.8	7.9	2.2	8.5	20.4	11.4	2.2	6.8	21.0	14.8
1.5	12.0	12.0	6.7	1.5	11.0	14.2	9.1	1.5	4.9	22.5	15.1	1.5	4.9	25.0	17.4
1.0	9.6	14.1	7.5	1.0	6.2	16.0	12.1	1.0	3.7	24.4	17.3	1.0	2.6	34.6	23.9
0.68	7.6	15.9	8.43	0.68	5.2	20.2	13.2	0.68	2.92	29.0	19.5				
0.33	4.85	21.8	10.5												

LE type

6 x 6				7 x 7			
M0648M-LE				M0748M-LE			
ETQP4M__KFN				ETQP4M__KFM			
 6.5 x 6.0 x H4.8 (mm)				 7.5 x 7.0 x H4.8 (mm)			
L0 (μ H)	DCR (m Ω)	Rated current (A)		L0 (μ H)	DCR (m Ω)	Rated current (A)	
		Δ L:-30%	Δ T:+40K			Δ L:-30%	Δ T:+40K
				47.0	148.6	3.7	2.9
				22.0	84.1	4.6	3.9
15.0	63.8	6.7	4.2				
10.0	40.4	8.1	5.2	10.0	36.0	9.6	6.0
4.7	20.7	9.3	7.3	4.7	16.8	10.7	8.8
3.3	13.1	12.0	9.2				

Please visit our website
for LP type !





Please visit our website
for LE type !

- ◆ Rated current is the current value at which temperature rise is 40K. Please use within Tc 155°C including self-temperature rise.
- ◆ The proven current value for making the overall temperature rise of 40k, when mounted on multi-layer board with high-heat dissipation.



6-3. High power type / Vibration proof type

High power type

10 x 10 (Low-DCR)* ¹								12 x 12* ²			
M1050ML				M1060ML				M1280MF			
ETQP5M_YLC				ETQP6M_YLC				ETQP8M_JFA			
 10.9 x 10.0 x H5.0 (mm)				 10.9 x 10.0 x H6.0 (mm)				 12.6 x 13.1/13.2 x H8.0 (mm)			
L0 (μH)	DCR (mΩ)	Rated current (A)		L0 (μH)	DCR (mΩ)	Rated current (A)		L0 (μH)	DCR (mΩ)	Rated current (A)	
		ΔL:-30%	ΔT:+40K			ΔL:-30%	ΔT:+40K			ΔL:-30%	ΔT:+40K (4-layer)
				4.7	8.70	22.5	14.1	4.7	4.90	24.7	20.2
				3.3	6.00	26.3	17.0	3.3	3.60	27.6	23.6
				2.5	4.55	25.8	19.6	2.5	2.60	32.1	27.7
				1.5	3.20	32.0	23.3	1.5	1.80	29.9	33.3
1.0	2.30	37.8	27.5					1.0	1.36	44.4	38.3
0.68	1.75	40.0	31.5					0.68	1.10	56.9	42.6
0.33	1.10	56.7	39.7					0.33	0.70	84.5	53.5

Please visit our website
for high power type !



Vibration proof type* ¹							
8 x 8				10 x 10 (Low-DCR)			
M0854MS				M1050MS/M1060MS			
ETQP5M_YSK				ETQP5M_YSC/ETQP6M_YSC			
 8.5 x 8.0 x H5.4 (mm)				 10.9 x 10.0 x H5.0/H6.0 (mm)			
L0 (μH)	DCR (mΩ)	Rated current (A)		L0 (μH)	DCR (mΩ)	Rated current (A)	
		ΔL:-30%	ΔT:+40K			ΔL:-30%	ΔT:+40K
2.45	7.4	19.3	14.1				
				1.9	4.45	30.0	16.5
				0.68	1.66	40.0	32.3

Please visit our website
for vibration proof type !



*1: Rated current is the current value at which temperature rise is 40K. Please use within Tc 150°C including self-temperature rise.

*2: Rated current is the current value at which temperature rise is 40K. Please use within Tc 160°C including self-temperature rise.

◆The proven current value for making the overall temperature rise of 40k, when mounted on multi-layer board with high-heat dissipation.

7-1. Simulation data libraries

Equivalent circuit models, and S-parameter data can be downloaded for each individual item number.

Simulation Data Libraries

7-2. Industrial & Automotive use LC filter simulator

The Industrial & Automotive use LC filter simulator enables the simulation of attenuation amounts when configuring a filter using Panasonic's power inductor and aluminum electrolytic capacitor suitable for industrial & automotive use.

LC Filter Simulator

7-3. Power inductor loss simulator

The Power Inductor loss simulator for automotive application enables the simulation of losses and temperature rises according to the current for Panasonic's power inductors designed for automotive use.

Loss Simulator

Safety Precautions

When using our products, no matter what sort of equipment they might be used for, be sure to confirm the applications and environmental conditions with our specifications in advance.

Panasonic
INDUSTRY

Panasonic Corporation
Device Solutions Business Division
Industrial Company
1006 Kadoma, Kadoma City, Osaka
571-8506 Japan